

# MEC1406-34

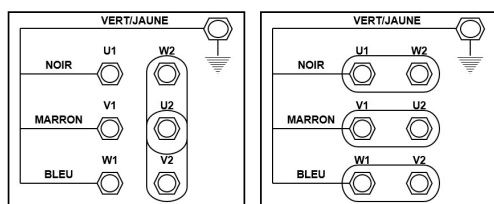

## Opening/shading motorisation + Ø34 chain couplings



Raccordement de la plaque à bornes



Ø34 tubular chain coupling: MEC1101

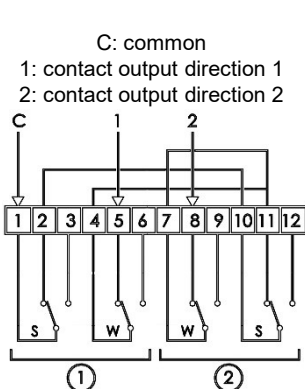

Limit switch wiring diagram

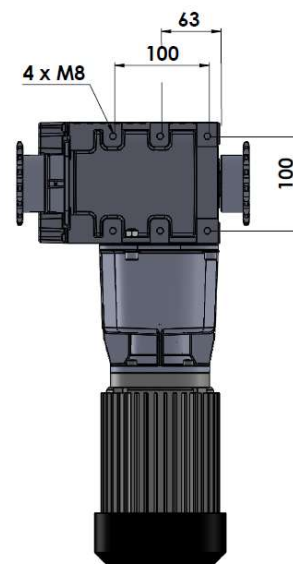
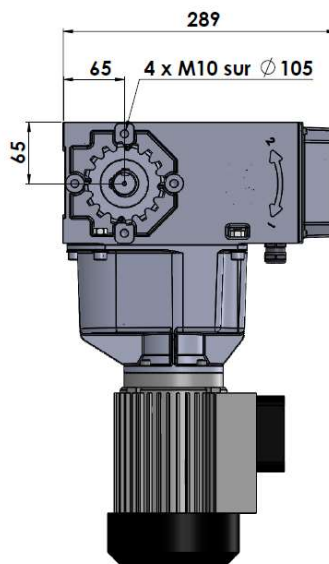
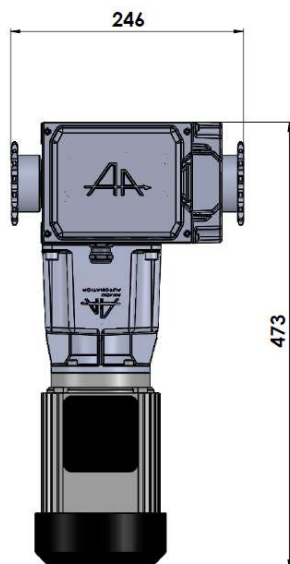

### Description

Sealed construction in aluminium casing

Non reversible load

Manual operation on electric motor

Tool-free leak tight adjustable limit switch

Adjustable 33 rotation limit switch stroke

Location reserved for addition of the MISSI line

Two possible fixtures: side and back

### Specifications

Torque	240Nm	
Coupling	Ø34 tubular chain	
Rotation speed	5.0rpm	
Motor power	0.37kW	
Three-phased	50Hz – 230/400V	1.1A
	60Hz – 280/460V	1.9A
Weight	26kg	