

MEC1402-32

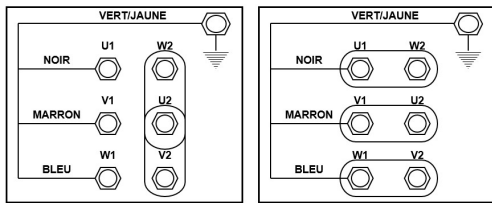

Opening/shading motorisation + Ø32 chain couplings



Raccordement de la plaque à bornes



Ø32 tubular chain coupling: MEC1100

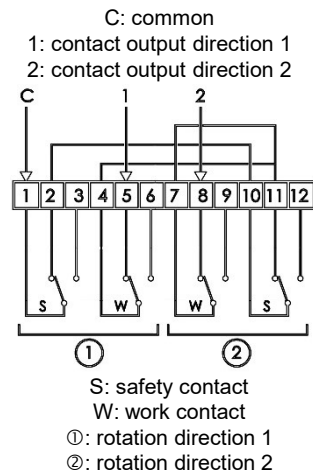

Limit switch wiring diagram

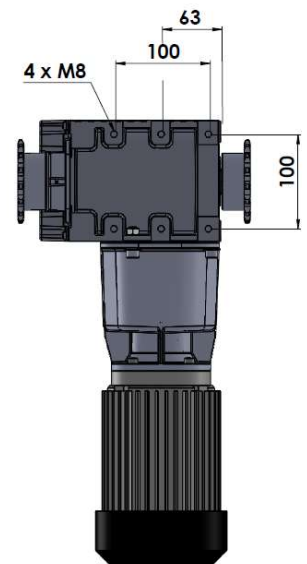
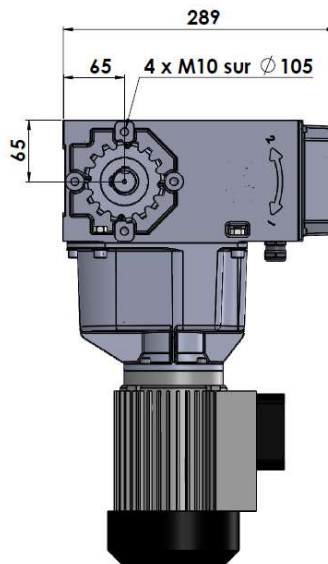
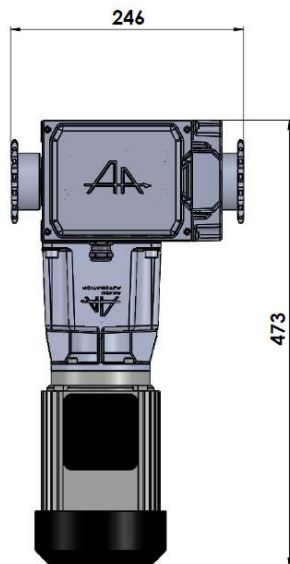

Description

Sealed construction in aluminium casing

Non reversible load

Manual operation on electric motor

Tool-free leak tight adjustable limit switch

Adjustable 33 rotation limit switch stroke

Location reserved for addition of the MISSI line

Two possible fixtures: side and back

Specifications

Torque 350Nm

Coupling Ø32 tubular chain

Rotation speed 5.0rpm

Motor power 0.55kW

Three-phased 50Hz – 230/400V 2.6A
60Hz – 280/460V 1.5A

Weight 26kg