

MEC0141



1/4 direct roll-up gear (max. height: 2.50m)

Description
Non reversible transmission under load
Sealed assembly on bearings in a white powder-coated aluminium casing with top-up greaser
Zinc plated output shaft for Ø32mm, Ø34 or square 25x25x1.5 roll-up tube
Galvanised steel Ø26 tube handle

Specifications	
Gear	1/4
Operation	Manual
Ø60 (aluminium tube) max. single rolling length	50m
Ø32 or Ø34 max. single rolling length	75m
Input torque	12Nm
Output torque	42Nm
Weight	6.5kg

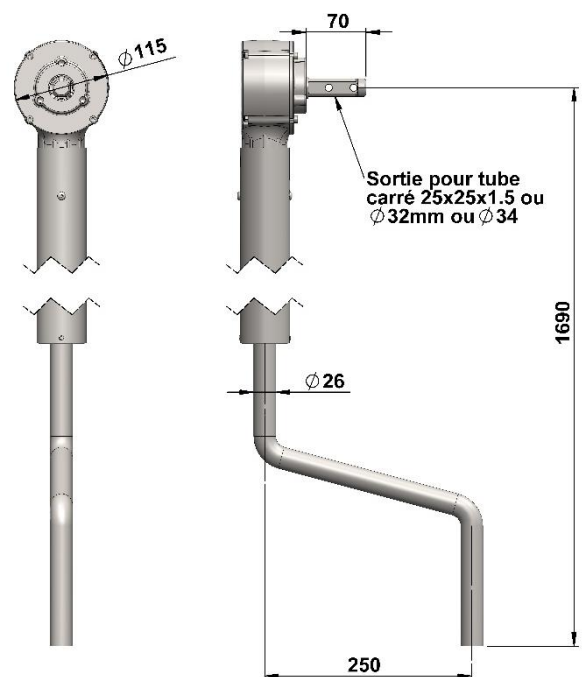

880 rue Léo Baekeland
85290 Mortagne sur Sèvre- France
+33 (0)2 02 51 63 02
contact@anjouautomation.fr

 **Anjou
Automation**
L'innovation est notre culture